

# Ultra Low Ohm (Metal Strip) Chip Resistor – LR Series

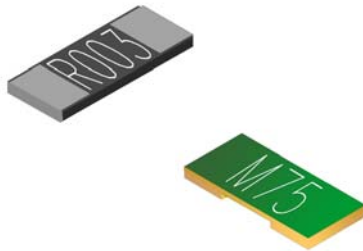

## Features

- High Wattage Rating Up to 3W
- Low TCR  $\pm 50, \pm 100$  PPM/°C
- Resistance Values from 0.5 to 22 m ohms
- Without Laser Trimmed with Very Low Inductance
- Customized Resistance Available
- 1206 / 2010 / 2512 are Available

## Applications

- NB (for Power Management)
- MB (for Power Management)
- SWPS (DC-DC Converter, Charger, Adaptor)
- Monitor (for Power Management)

## Construction

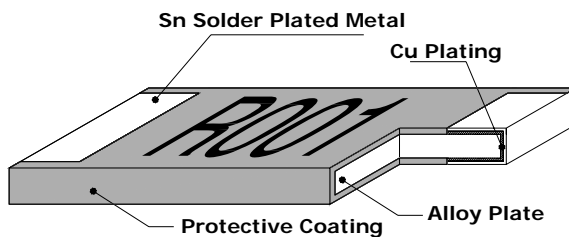
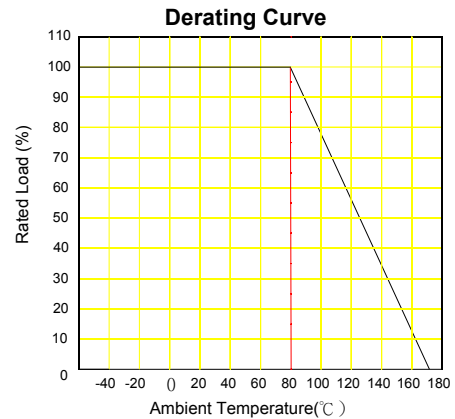

Figure 1

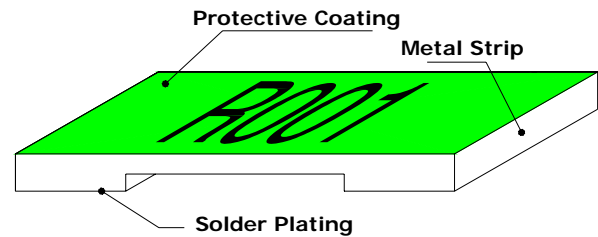
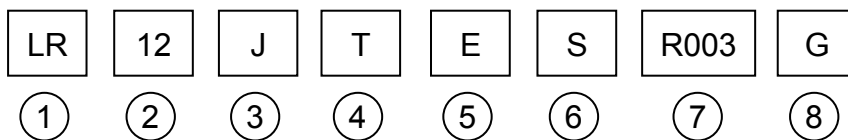

Figure 2

## Part Numbering



### ① Product Type

Product Type	Type
LR	Ultra Low Ohm Metal Strip Chip Resistor

### ② Dimensions (L×W)

Codes	Dimensions (L×W)	EIA
LR12	6.3×3.1mm	2512
LR10	5.1×2.5mm	2010
LR06	3.2×1.6mm	1206

### ③ Resistance Tolerance

Codes	Resistance Tolerance
J	$\pm 5\%$
H	$\pm 3\%$
G	$\pm 2\%$
F	$\pm 1\%$

### ④ Packaging

Code	Type
T	Taping Reel

### ⑤ TCR

Codes	Type
D	$\pm 50$ PPM/°C
W	$\pm 75$ PPM/°C
E	$\pm 100$ PPM/°C
K	$\pm 150$ PPM/°C

### ⑥ Power Rating

Codes	Type
	Standard (1W)
A	(1.5W)
S	(2W)
R	(3W)
B	(2.5W)

### ⑦ Resistance

Codes	Type
0M50	0.00050Ω
0M75	0.00075Ω
1M50	0.00150Ω
R002	0.00200Ω
R020	0.02000Ω

### ⑧ Protective Coating

Codes	Type
	Black Coating
G	Green Coating

## Dimensions

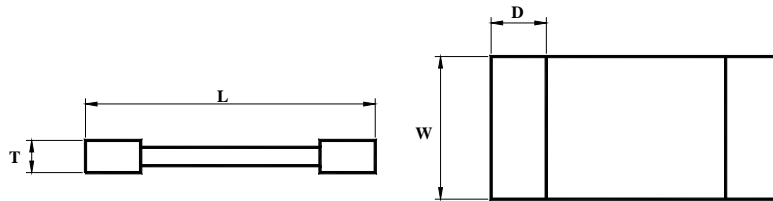

Unit: mm

Part No.	Resistance(m Ω)	L	W	T	D
LR12□T□□□□□G	0.50~0.75	6.35±0.25	3.18±0.35	1.00±0.20	1.93±0.75
LR12□T□□□□□G	1.0~22	6.35±0.25	3.18±0.35	0.60±0.20	1.93±0.75
LR12□T□0M50	0.50	6.35±0.25	3.18±0.25	1.40±0.20	1.30±0.30
LR12□T□0M75	0.75	6.35±0.25	3.18±0.25	1.00±0.20	1.30±0.30
LR12□T□R001	1.00	6.35±0.25	3.18±0.25	0.80±0.20	1.30±0.30
LR12□T□1M50	1.50	6.35±0.25	3.18±0.25	0.65±0.20	1.30±0.30
LR12□T□R002	2.00	6.35±0.25	3.18±0.25	0.50±0.20	1.30±0.30
LR12□T□2M50	2.50	6.35±0.25	3.18±0.25	1.00±0.20	1.30±0.30
LR12□T□R003	3.00	6.35±0.25	3.18±0.25	0.70±0.20	1.30±0.30
LR12□T□3M50	3.50	6.35±0.25	3.18±0.25	0.71±0.20	1.30±0.30
LR12□T□R004	4.00	6.35±0.25	3.18±0.25	0.60±0.20	1.30±0.30
LR12□T□4M50	4.50	6.35±0.25	3.18±0.25	0.58±0.20	1.30±0.30
LR12□T□R005	5.00	6.35±0.25	3.18±0.25	0.50±0.20	1.30±0.30
LR12□T□5M50	5.50	6.35±0.25	3.18±0.25	0.47±0.20	1.30±0.30
LR12□T□R006	6.00	6.35±0.25	3.18±0.25	0.50±0.20	1.30±0.30
LR12□T□6M50	6.50	6.35±0.25	3.18±0.25	0.47±0.20	1.30±0.30
LR12□T□R007	7.00	6.35±0.25	3.18±0.25	0.45±0.20	1.30±0.30
LR12□T□R010	10.0	6.50±0.35	3.20±0.25	0.80±0.15	1.90±0.15
LR10□T□□□□□G	1.0~10	5.08±0.25	2.54±0.15	0.60±0.20	1.67±0.63
LR06□T□□□□□G	1.0~10	3.20±0.25	1.60±0.10	0.60±0.20	0.98±0.38

## Standard Electrical Specifications

Type	Item	Power Rating at 80°C	Operating Temp. Range	Resistance Tolerance (±%)	Resistance (mΩ)	TCR (PPM/°C)
LR12□TD□□□□		1W	-55°C ~ +170°C	1,3,5	0.5~2.0	50
LR12□TK□□□□		1W		1,3,5	2.5~3.0	150
LR12□TE□□□□		1W		1,3,5	4.0~5.5	100
LR12□TW□□□□		1W		1,3,5	6.0~7.0	75
LR12□TER010		1W		1,3,5	10	100
LR12□TD□□□□G		1W		1,3,5	8.0~22	50
LR06□TD□□□□G		1W		1,3,5	1.0~10	50

Operating Current  $I = \sqrt{P/R}$ ; Operating Voltage  $V = \sqrt{P \cdot R}$

## High Power Rating Electrical Specifications

Type	Item	Power Rating at 80°C	Operating Temp. Range	Resistance Tolerance (±%)	Resistance (mΩ)	TCR (PPM/°C)
LR12□TDS□□□□		2.0W	-55°C ~ +170°C	1,3,5	0.5~2.0	50
LR12□TDS□□□□G		2.0W		1,3,5	7.0~10.0	50
LR12□TDB□□□□G		2.5W		1,3,5	4.0~6.0	50
LR12□TWR□□□□G		3.0W		1,3,5	3.0	75
LR12□TDR□□□□G		3.0W		1,3,5	1.0~2.0	50
LR12□TER□□□□G		3.0W		1,3,5	0.5~0.75	100
LR10□TDA□□□□G		1.5W		1,3,5	1.0~10	50

Operating Current  $I = \sqrt{P/R}$ ; Operating Voltage  $V = \sqrt{P \cdot R}$

\* Viking is capable of manufacturing the optional spec based on customer's requirement.

## Packaging

### Packaging Quantity

Unit: EA

Series	Emboss Plastic Tape
LR12	2,000
LR10	2,000
LR06	2,000

### Emboss Plastic Tape Specifications

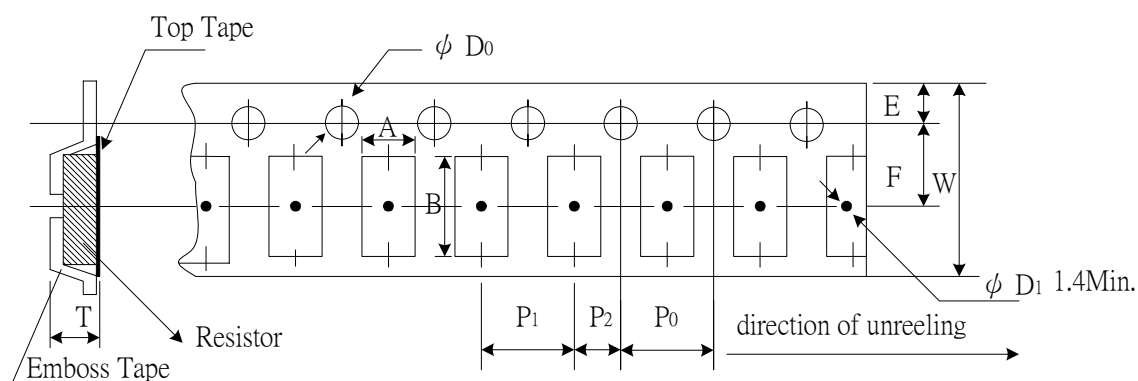

Unit: mm

Size	Resistance (mΩ)	A	B	W	E	F	P <sub>0</sub>	P <sub>1</sub>	P <sub>2</sub>	ΦD <sub>0</sub>	T
LR12	0.50	3.40±0.1	6.70±0.1	12.0±0.1	1.75±0.1	5.5±0.05	4.0±0.05	4.00±0.1	2.0±0.05	1.50±0.1	1.40±0.1
	0.75	3.50±0.1	6.80±0.2	12.0±0.1	1.75±0.1	5.5±0.05	4.0±0.05	4.00±0.1	2.0±0.05	1.50±0.1	1.35±0.1
	1~22	3.40±0.1	6.70±0.1	12.0±0.1	1.75±0.1	5.5±0.05	4.0±0.05	4.00±0.1	2.0±0.05	1.50±0.1	0.80±0.1
LR10	1~10	2.85±0.1	5.55±0.1	12.0±0.2	1.75±0.1	5.5±0.05	4.0±0.10	4.00±0.1	2.0±0.05	1.50±0.1	0.85±0.1

Notice:

1. The cumulative tolerance of 10 sprocket hole pitch is  $\pm 0.2$ mm.
2. Carrier camber shall be not more than 1mm per 100mm through a length of 250mm.
3. A & B measured 0.3mm from the bottom of the packet
4. t measured at a point on the inside bottom of the packet to the top surface of the carrier.
5. Pocket position relative to sprocket hole is measured as the true position of the pocket and not the pocket hole.

## Environmental Characteristics

Item	Specification		Test Method	
	Black coating	Green coating		
1	Temperature Coefficient of Resistance	As Spec.		MIL-STD-202F- Method 304 +25/-55/+25/+125/+25°C
2	Thermal Shock	±0.5%	±1%	MIL-STD-202F- Method 107G -55°C~150°C, 100 cycles
3	Short Time Overload	±0.5%	±1%	JIS-C-5202-5.5 5×rated power · 5 seconds
4	Resistance to Dry Heat	±1%	±1%	JIS-C-5202-7.2 96 hours @ +170°C without load
5	Load Life	±1%	±1%	MIL-STD-202F-Method 108A RCWV, 70°C, 1.5 hours on, 0.5 hours off, total 1000~1048 hours
6	Resistance to Soldering Heat	±0.5%	±1%	MIL-STD-202F-Method 210E 260±5°C, 10±1seconds
7	Solderability	95% min coverage		MIL-STD-202F-Method 208H 245±5°C, 2±0.5seconds

\* Storage Temperature :25±3°C; Humidity <80%RH