



# Zinc Oxide Varistor

## SPECIFICATION

### ■ TVA Series (Lightning Protection)

#### ● Features

1. Body size  $\phi 25 \sim \phi 60\text{mm}$
2. Broad operating voltage
3.  $-40 \sim +85^{\circ}\text{C}$  operating temperature range
4. Excellent clamping ratio
5. Low leakage current
6. Large withstanding surge current capability
7. Bidirectional and symmetrical V/I characteristics

#### ● Recommended Applications

1. Power supply
2. Home appliance
3. Industrial equipment
4. Telecommunication or telephone system

#### ● Approvals



- \* UL 1414 Recognized (File#E186499)
- \* UL 1449 Recognized (File#E173642)





● **Apperance**

TVA 34 Type

**GKGE**

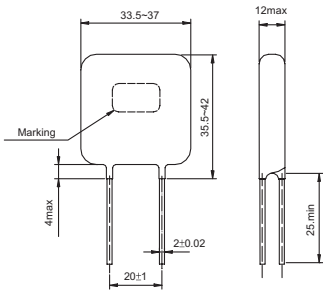

(Unit:mm)

**QKQE**

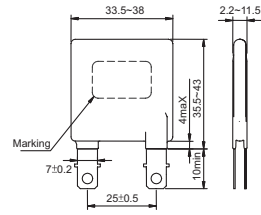

(Unit:mm)

**QKUS**

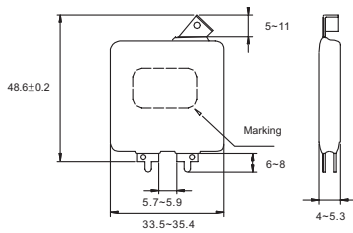

(Unit:mm)

**QKLS**

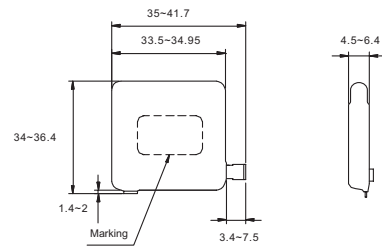

(Unit:mm)

**QKLE**

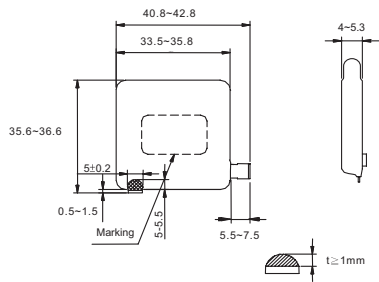

(Unit:mm)

**QKXE**

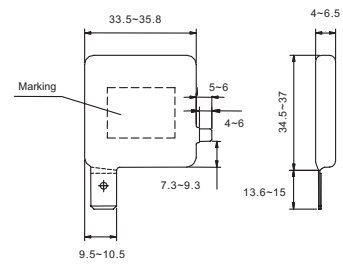

(Unit:mm)

**QKWE**

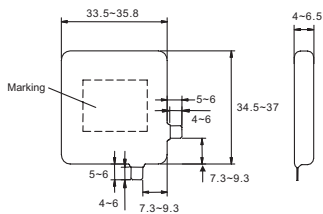

(Unit:mm)

**QKDE**

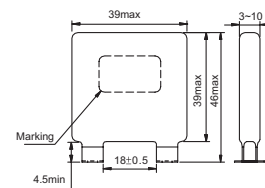

(Unit:mm)



**QKID**

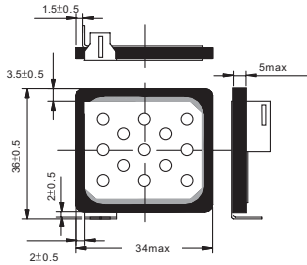

(Unit:mm)

**QKRE**

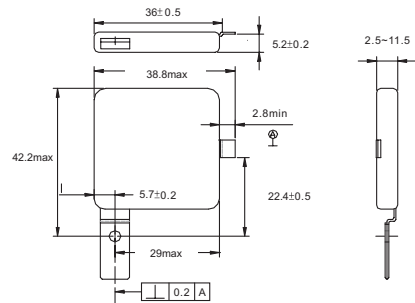

(Unit:mm)

**QKQS**

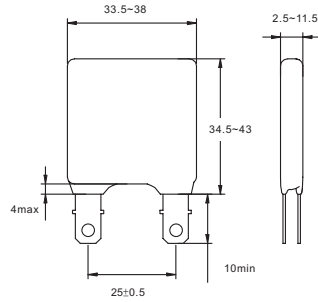

(Unit:mm)

**QKJD**

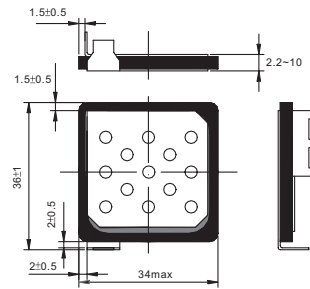

(Unit:mm)

**QKEE**

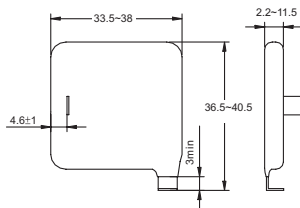

(Unit:mm)

**YKYN**

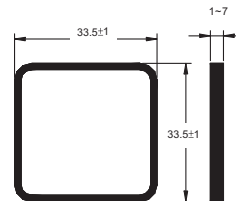

(Unit:mm)

TVA 34 -T Type

**TKTE**

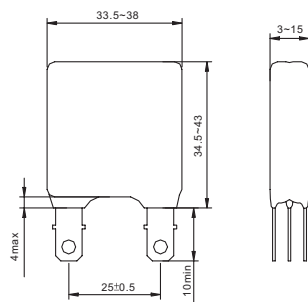

(Unit:mm)

**TKNN**

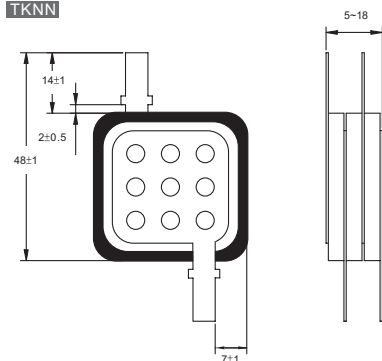

(Unit:mm)



● Characteristics

Part No.	Normal Varistor Voltage	Max. Allowable Voltage		Max. Clamping Voltage (8/20 $\mu$ s)		Max. Surge Current (8/20 $\mu$ s)	Max. Energy (2ms)	Rated Power	Reference Capacitance @1KHz
	V <sub>1mA</sub> (V)	V <sub>AC(rms)</sub> (V)	V <sub>DC</sub> (V)	V <sub>p</sub> (V)	I <sub>p</sub> (A)	I <sub>max</sub> (A)	W <sub>max</sub> (J)	P (W)	C (PF)
TVA25201K□□□□	200	130	170	340	150	15000	128	1	2200
TVA32201K□□□□	200	130	170	340	200	25000	210	1.2	3900
TVA34201K□□□□	200	130	170	340	300	40000	310	1.4	5600
TVA34201KT □□□□	200	130	170	340	500	70000	410	1.6	14040
TVA40201K□□□□	200	130	170	340	300	40000	310	1.4	6000
TVA25221K□□□□	220	140	180	365	150	15000	135	1	2000
TVA32221K□□□□	220	140	180	365	200	25000	225	1.2	3500
TVA34221K□□□□	220	140	180	365	300	40000	340	1.4	5000
TVA34221KT □□□□	220	140	180	365	500	70000	451	1.6	12760
TVA40221K□□□□	220	140	180	365	300	40000	340	1.4	5500
TVA25241K□□□□	240	150	200	395	150	15000	146	1	1900
TVA32241K□□□□	240	150	200	395	200	25000	240	1.2	3300
TVA34241K□□□□	240	150	200	395	300	40000	360	1.4	4800
TVA34241KT □□□□	240	150	200	395	500	70000	490	1.6	11700
TVA40241K□□□□	240	150	200	395	300	40000	360	1.4	5000
TVA60241K□□□□	240	150	200	395	500	70000	490	1.6	11700
TVA25271K□□□□	270	175	225	455	150	15000	170	1	1600
TVA32271K□□□□	270	175	225	455	200	25000	255	1.2	2800
TVA34271K□□□□	270	175	225	455	300	40000	400	1.4	4100
TVA34271KT □□□□	270	175	225	455	500	70000	550	1.6	10400
TVA40271K□□□□	270	175	225	455	300	40000	400	1.4	4500
TVA60271K□□□□	270	175	225	455	500	70000	550	1.6	10400
TVA25361K□□□□	360	230	300	595	150	15000	190	1	1300
TVA32361K□□□□	360	230	300	595	200	25000	300	1.2	2200
TVA34361K□□□□	360	230	300	595	300	40000	460	1.4	3200
TVA34361KT □□□□	360	230	300	595	500	70000	730	1.6	7800
TVA40361K□□□□	360	230	300	595	300	40000	460	1.4	3500
TVA60361K□□□□	360	230	300	595	500	70000	730	1.6	7800
TVA25391K□□□□	390	250	320	650	150	15000	210	1	1100
TVA32391K□□□□	390	250	320	650	200	25000	330	1.2	2000
TVA34391K□□□□	390	250	320	650	300	40000	490	1.4	2800
TVA34391KT □□□□	390	250	320	650	500	70000	800	1.6	7200
TVA40391K□□□□	390	250	320	650	300	40000	490	1.4	3000
TVA60391K□□□□	390	250	320	650	500	70000	800	1.6	7200
TVA25431K□□□□	430	275	350	710	150	15000	220	1	1000
TVA32431K□□□□	430	275	350	710	200	25000	360	1.2	1800
TVA34431K□□□□	430	275	350	710	300	40000	550	1.4	2600
TVA34431KT □□□□	430	275	350	710	500	70000	860	1.6	6600
TVA40431K□□□□	430	275	350	710	300	40000	550	1.4	2800
TVA60431K□□□□	430	275	350	710	500	70000	860	1.6	6600
TVA25471K□□□□	470	300	385	775	150	15000	225	1	950
TVA32471K□□□□	470	300	385	775	200	25000	405	1.2	1700
TVA34471K□□□□	470	300	385	775	300	40000	595	1.4	2400
TVA34471KT □□□□	470	300	385	775	500	70000	950	1.6	6100
TVA40471K□□□□	470	300	385	775	300	40000	595	1.4	2600
TVA60471K□□□□	470	300	385	775	500	70000	950	1.6	6100



Part No.	Normal Varistor Voltage	Max. Allowable Voltage		Max. Clamping Voltage (8/20 $\mu$ s)		Max. Surge Current (8/20 $\mu$ s)	Max. Energy (2ms)	Rated Power	Reference Capacitance @1KHz
	V <sub>1mA</sub> (V)	V <sub>AC(rms)</sub> (V)	V <sub>DC</sub> (V)	V <sub>p</sub> (V)	I <sub>p</sub> (A)	I <sub>max</sub> (A)	W <sub>max</sub> (J)	P (W)	C (PF)
TVA25511K□□□□	510	320	415	845	150	15000	230	1	900
TVA32511K□□□□	510	320	415	845	200	25000	430	1.2	1600
TVA34511K□□□□	510	320	415	845	300	40000	640	1.4	2300
TVA34511KT□□□	510	320	415	845	500	70000	1000	1.6	5800
TVA40511K□□□□	510	320	415	845	300	40000	640	1.4	2500
TVA60511K□□□□	510	320	415	845	500	70000	1000	1.6	5800
TVA25561K□□□□	560	350	450	930	150	15000	235	1	800
TVA32561K□□□□	560	350	450	930	200	25000	470	1.2	1400
TVA34561K□□□□	560	350	450	930	300	40000	710	1.4	2000
TVA34561KT□□□	560	350	450	930	500	70000	1100	1.6	5100
TVA40561K□□□□	560	350	450	930	300	40000	710	1.4	2200
TVA60561K□□□□	560	350	450	930	500	70000	1100	1.6	5100
TVA25621K□□□□	620	385	505	1025	150	15000	240	1	700
TVA32621K□□□□	620	385	505	1025	200	25000	550	1.2	1250
TVA34621K□□□□	620	385	505	1025	300	40000	800	1.4	1800
TVA34621KT□□□	620	385	505	1025	500	70000	1200	1.6	4600
TVA40621K□□□□	620	385	505	1025	300	40000	800	1.4	2000
TVA60621K□□□□	620	385	505	1025	500	70000	1200	1.6	4600
TVA25681K□□□□	680	420	560	1120	150	15000	250	1	650
TVA32681K□□□□	680	420	560	1120	200	25000	600	1.2	1150
TVA34681K□□□□	680	420	560	1120	300	40000	910	1.4	1700
TVA34681KT□□□	680	420	560	1120	500	70000	1500	1.6	4300
TVA40681K□□□□	680	420	560	1120	300	40000	910	1.4	1800
TVA60681K□□□□	680	420	560	1120	500	70000	1500	1.6	4300
TVA25751K□□□□	750	460	615	1240	150	15000	275	1	600
TVA32751K□□□□	750	460	615	1240	200	25000	660	1.2	1100
TVA34751K□□□□	750	460	615	1240	300	40000	1000	1.4	1600
TVA34751KT□□□	750	460	615	1240	500	70000	1650	1.6	4100
TVA40751K□□□□	750	460	615	1240	300	40000	1000	1.4	1700
TVA60751K□□□□	750	460	615	1240	500	70000	1650	1.6	4100
TVA25781K□□□□	780	485	640	1290	150	15000	290	1	550
TVA32781K□□□□	780	485	640	1290	200	25000	680	1.2	1050
TVA34781K□□□□	780	485	640	1290	300	40000	1030	1.4	1500
TVA34781KT□□□	780	485	640	1290	500	70000	1700	1.6	3800
TVA40781K□□□□	780	485	640	1290	300	40000	1030	1.4	1600
TVA60781K□□□□	780	485	640	1290	500	70000	1700	1.6	3800
TVA25821K□□□□	820	510	670	1355	150	15000	300	1	520
TVA32821K□□□□	820	510	670	1355	200	25000	550	1.2	950
TVA34821K□□□□	820	510	670	1355	300	40000	860	1.4	1400
TVA34821KT□□□	820	510	670	1355	500	70000	1350	1.6	3600
TVA40821K□□□□	820	510	670	1355	300	40000	860	1.4	1500
TVA60821K□□□□	820	510	670	1355	500	70000	1350	1.6	3600
TVA25911K□□□□	910	550	745	1500	150	15000	340	1	500
TVA32911K□□□□	910	550	745	1500	200	25000	620	1.2	900
TVA34911K□□□□	910	550	745	1500	300	40000	960	1.4	1300
TVA34911KT□□□	910	550	745	1500	500	70000	1500	1.6	3300
TVA40911K□□□□	910	550	745	1500	300	40000	960	1.4	1400
TVA60911K□□□□	910	550	745	1500	500	70000	1500	1.6	3300



Part No.	Normal Varistor Voltage	Max. Allowable Voltage		Max. Clamping Voltage (8/20 $\mu$ s)		Max. Surge Current (8/20 $\mu$ s)	Max. Energy (2ms)	Rated Power	Reference Capacitance @1KHz
	V <sub>1mA</sub> (V)	V <sub>AC(ms)</sub> (V)	V <sub>DC</sub> (V)	V <sub>p</sub> (V)	I <sub>p</sub> (A)	I <sub>max</sub> (A)	W <sub>max</sub> (J)	P (W)	C (PF)
TVA25951K□□□□	950	575	765	1570	150	15000	355	1	450
TVA32951K□□□□	950	575	765	1570	200	25000	660	1.2	850
TVA34951K□□□□	950	575	765	1570	300	40000	1000	1.4	1200
TVA34951KT □□□	950	575	765	1570	500	70000	1560	1.6	3000
TVA40951K□□□□	950	575	765	1570	300	40000	1000	1.4	1300
TVA60951K□□□□	950	575	765	1570	500	70000	1560	1.6	3000
TVA25102K□□□□	1000	625	825	1650	150	15000	375	1	430
TVA32102K□□□□	1000	625	825	1650	200	25000	690	1.2	800
TVA34102K□□□□	1000	625	825	1650	300	40000	1050	1.4	1150
TVA34102KT □□□	1000	625	825	1650	500	70000	1650	1.6	2900
TVA40102K□□□□	1000	640	825	1650	300	40000	1050	1.4	1200
TVA60102K□□□□	1000	625	825	1650	500	70000	1650	1.6	2900
TVA25112K□□□□	1100	680	895	1815	150	15000	390	1	400
TVA32112K□□□□	1100	680	895	1815	200	25000	760	1.2	750
TVA34112K□□□□	1100	680	895	1815	300	40000	1150	1.4	1050
TVA34112KT □□□	1100	680	895	1815	500	70000	1800	1.6	2700
TVA40112K□□□□	1100	680	895	1815	300	40000	1150	1.4	1100
TVA60112K□□□□	1100	680	895	1815	500	70000	1800	1.6	2700
TVA32122K□□□□	1200	750	980	2000	200	25000	800	1.2	650
TVA34122K□□□□	1200	750	980	2000	300	40000	1250	1.4	950
TVA34122KT □□□	1200	750	980	2000	500	70000	2000	1.6	2500
TVA40122K□□□□	1200	750	980	2000	300	40000	1250	1.4	1000
TVA60122K□□□□	1200	750	980	2000	500	70000	2000	1.6	2500
TVA60182K□□□□	1800	1000	1465	2970	500	70000	3000	1.6	1800

Note : □□□□/□□□ : Please read the dimensions